

**Matala**<sup>®</sup>  
Make water alive

# HAKKO

*Linear Air Pumps*



**High Efficiency**  
**Simple Maintenance**  
**Completely Oil-Free**

**Overload Protection**  
**Silent Operation**  
**Long Life Expectancy**

### HK-20

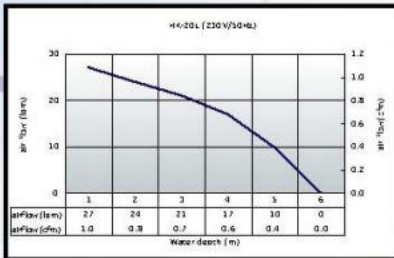

### HK-40

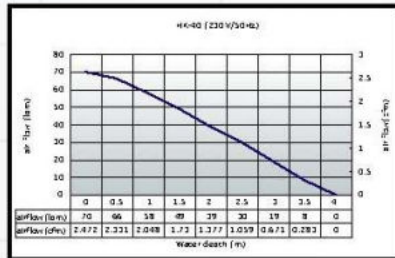

### HK-60

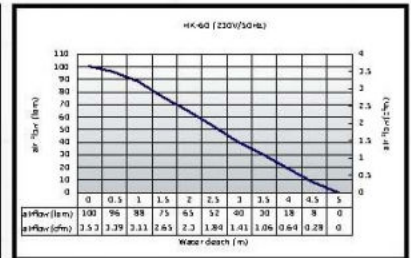

### HK-80

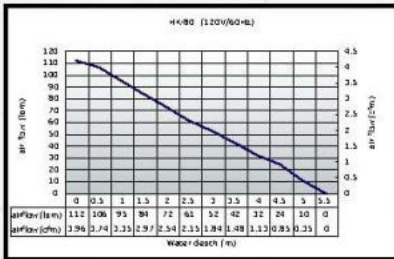

### HK-100

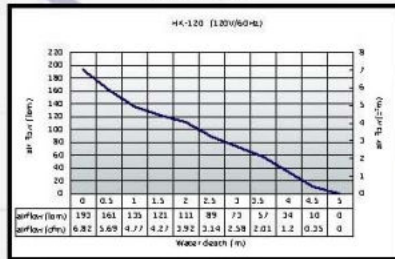

### HK-120

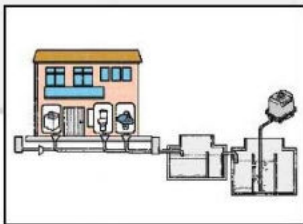
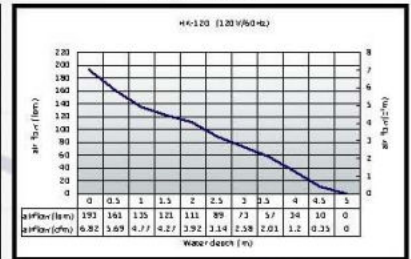

• Aeration for sewage treatment systems

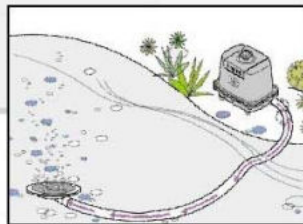

• Aeration for water garden pond

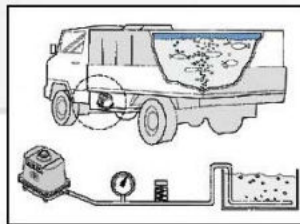

• Aeration for fish Transport

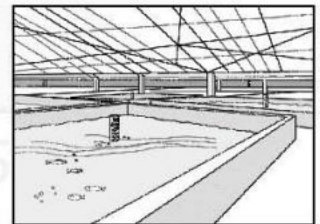

• Aeration for Aquaculture

Water depth (m)

# HAKKO

## Linear Air Pumps

LINEAR AIR PUMP PERFORMANCE CURVE  
Pressure unit : water depth in meter

HK-20

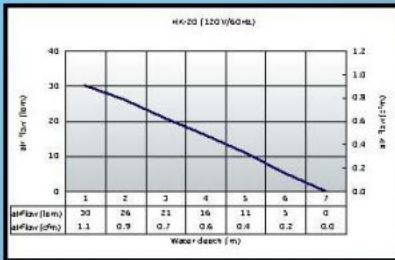

HK-40

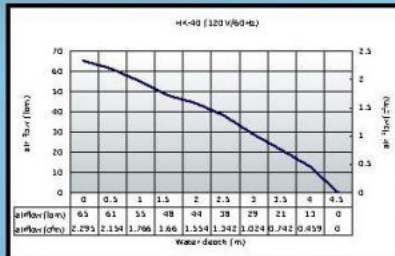

HK-60

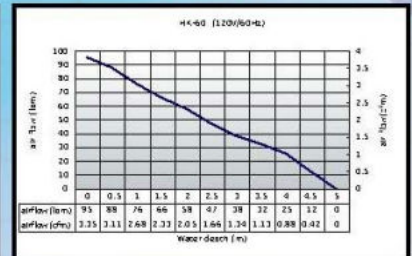

HK-80

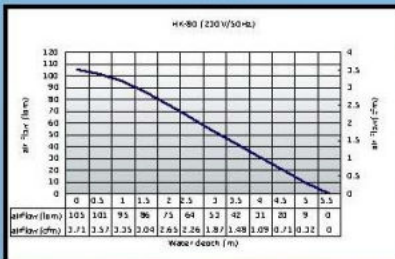

HK-100

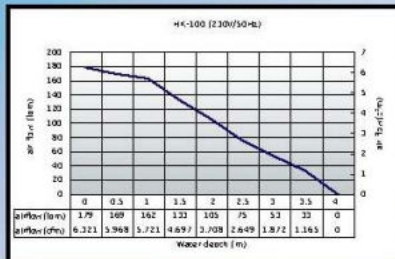

HK-120

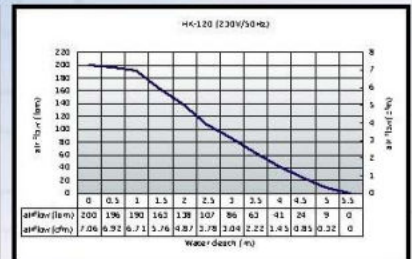

### DIMENSIONS

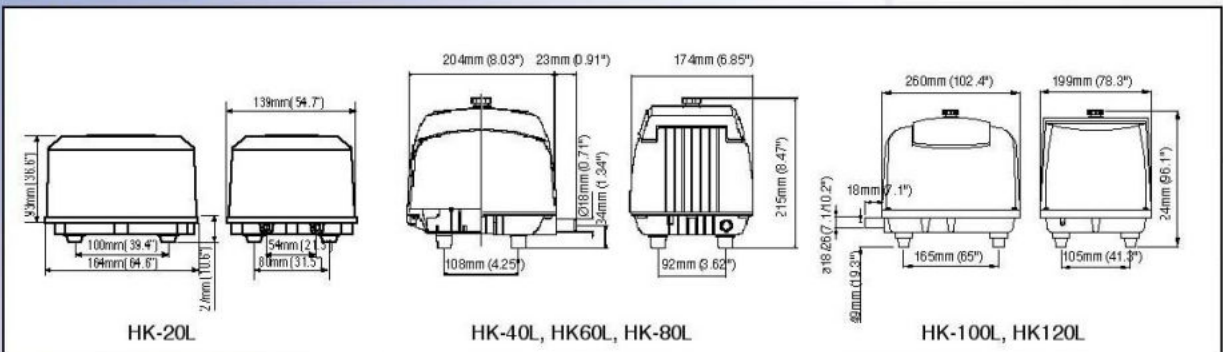

cfm) 3.35 3.11

HK-60 (120V/60Hz)

# HAKKO *Linear Air Pumps*

## SPECIFICATION

Model		HK-20	HK-40	HK-60	HK-80	HK-100	HK-120
SPECIFICATION Item							
Rated Voltage (V)		AC 115 (AC 110/115/120 or AC 220/230/240)					
Power supply frequency (Hz)		50 / 60					
Normal pressure (bar/psi)		0.1(1.42psi)	0.13(1.85psi)	0.15(2.13psi)		0.13(2.56psi)	0.20(2.84psi)
Rated performance(lpm, cfm)		21	51	68	86	118	132
Power (w)		17	40	63	85	116	126
Noise level (dB)		32	35	38	38	40	42
Closed pressure	bar	0.26	0.38	0.46	0.54	0.45	0.54
	psi	3.7	5.5	6.7	7.8	6.5	7.8
weight (kg)		2.9, 6.27	5.4, 11.9	6.3, 13.8	6.3, 13.8	8.9, 19.6	8.9, 19.6

\*The above specifications are subject to change without prior notice.

DISTRIBUTED BY

